

LIFTING DEVICE 62°

TECHNICAL SPECIFICATIONS

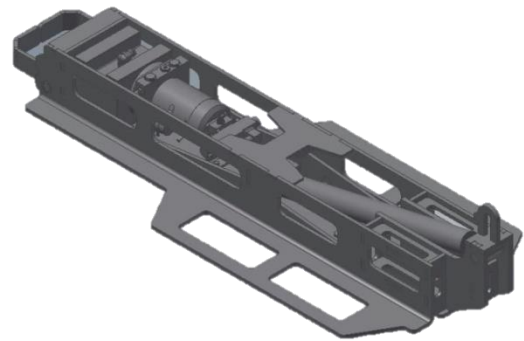
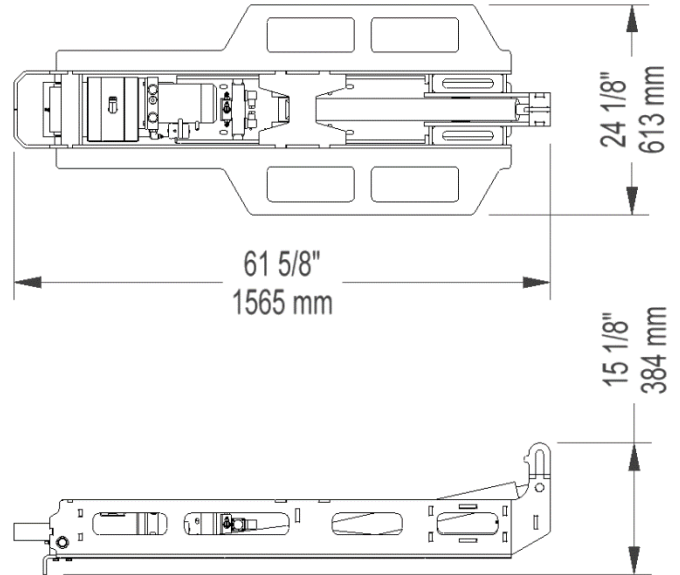
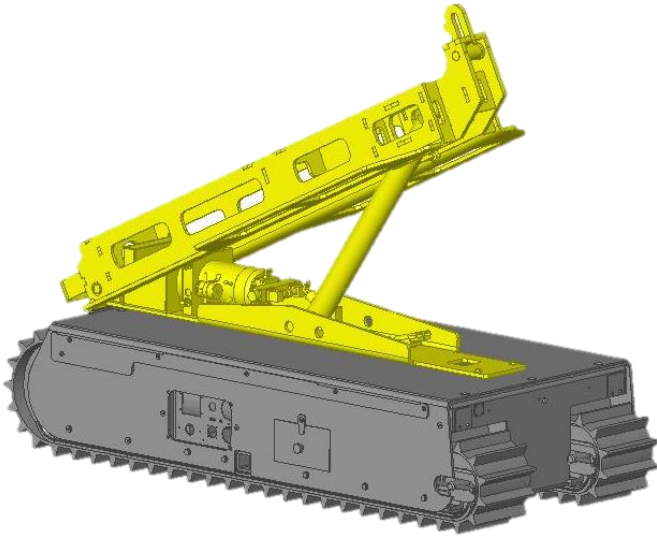

PHYSICAL CHARACTERISTICS

Material	Steel	
Length	61 5/8 in	1565 mm
Width	24 1/8 in	613 mm
Height	15 1/8 in	384 mm
Weight	300 lb	136 kg
Lifting capacity*	1130 lb	514 kg
Maximum lifting angle	62°	

COMPATIBLE WITH :

- Twin-Track 66
- Heavy-Duty
- Cross-Country

* This lifting capacity have been tested with a Twin-Track 66 model. The lifting capacity may vary depending on the Track-O model and the accessory installed. Refer to the technical specifications of the Track-O model or the accessory installed to know the real maximum capacities of your installation.

The information contained in this document is subject to change without notice.